

44 **ruedas arsa**

## RUEDAS PARA BRICOLAGE, DECORACIÓN Y MOBILIARIO COMERCIAL

**Soporte** de acero estampado, acabado cincado brillante.  
**Giratorio**, sobre una hilera de bolas en acero templado.

**Sistema de Fijación:**

Pasador, para tornillo o espiga.  
 Platina, para cuatro tornillos.













**Aro:** de polipropileno gris.

**Aro:** doble de polipropileno gris.

**Tipo de Eje:**

Liso, remachado al soporte.

CUADRO GENERAL DE COTAS Y CARGAS

											
25	15	7	35	40	13	-	40 x 40	21 x 35	5	6,5	-
30	15	12	44	48	17	-	40 x 40	27 x 27	5	7	-
30	15 x 2	18	46	50	15	-	45 x 45	32 x 32	5	7	-
40	15	15	53	57	19	-	40 x 40	27 x 27	5	7	-
40	17 x 2	25	55	60	20	-	50 x 50	34 x 34	6	8	-

Giratoria Pasador

		CODIGO
25 x 15		<b>2493</b>
30 x 15		<b>2494</b>
40 x 15		<b>2495</b>



Giratoria Platina

		CODIGO
25 x 15		<b>2496</b>
30 x 15		<b>2497</b>
40 x 15		<b>2498</b>



Giratoria Pasador

		CODIGO
30 x 15		<b>2511</b>
40 x 17		<b>2513</b>



Giratoria Platina

		CODIGO
30 x 15		<b>2521</b>
40 x 17		<b>2523</b>



40 **ruedas arsa**

**RUEDAS PARA BRICOLAGE, DECORACIÓN Y MOBILIARIO COMERCIAL**

**Soporte** de acero estampado, acabado cromado.

**Giratorio**, sobre doble hilera de bolas en acero templado.

**Sistema de Fijación:**

Pasador, para tornillo o espiga.

Espiga roscada, con rosca M-10x15.

Platina, para cuatro tornillos.

**Aro:** de polipropileno, con bandaje de goma termoplástica, color gris.

**Tipo de Eje:**

Liso, remachado al soporte.

**Opciones**

**Otros acabados:** Colores del soporte. (Según cantidades)

**Aro:** de goma negra.



**Espiga roscada,** M-8x20 y M-10x20.



**CUADRO GENERAL DE COTAS Y CARGAS**



40	40	25	59	62	35	42 x 42	32 x 32	4,2	10	10	15
50	50	35	69	72	45	48 x 48	35 x 35	5	10	10	15

**Giratoria Pasador**

		<b>CODIGO</b>
		
40 x 40		<b>2781</b>
50 x 50		<b>2783</b>





**Giratoria Espiga Roscada**

		<b>CODIGO</b>
		
40 x 40		<b>2791</b>
50 x 50		<b>2793</b>



**Giratoria Platina**

		<b>CODIGO</b>
		
40 x 40		<b>2771</b>
50 x 50		<b>2773</b>



48 **ruedas arsa**

**RUEDAS PARA MOBILIARIO COMERCIAL Y COLECTIVIDADES**

**Soporte** de acero estampado, acabado cincado brillante.

**Fijo**

**Sistema de Fijación:**

Platina, para dos tornillos.

Platina, para cuatro tornillos.

**Aro:** de polipropileno, con bandaje de goma termoplástica, color gris.

**Aro:** de polipropileno, color negro.

**Tipo de Eje:**

Liso, remachado al soporte.

**Características Técnicas**

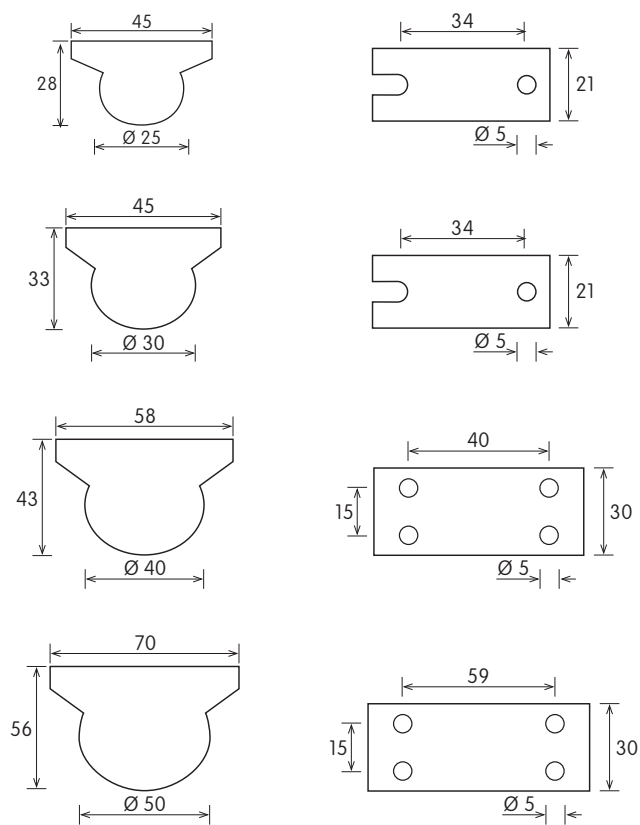



**CUADRO GENERAL DE COTAS Y CARGAS**

25	15	30	-	-	28	-	-	45 x 21	34	5	-	-
30	15	30	30	-	33	-	-	45 x 21	34	5	-	-
40	18	50	50	-	43	-	-	58 x 30	40 x 15	5	-	-
50	18	50	50	-	56	-	-	70 x 30	59 x 15	5	-	-



**ruedas arsa. 49**

Fija

			CODIGO
25 x 15			-
30 x 15			<b>31761</b>





Fija

			CODIGO
40 x 18			<b>31765</b>
50 x 18			<b>31767</b>





Fija

			CODIGO
25 x 15			<b>31770</b>
30 x 15			<b>31771</b>



Fija

			CODIGO
40 x 18			<b>31775</b>
50 x 18			<b>31777</b>

